

1) Match the definitions with the appropriate pictures:

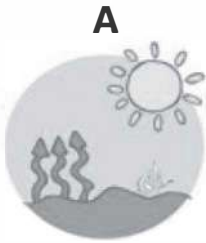

- 1- It happens when much water in the clouds falls back to earth.
- 2- Water vapour changes into clouds.
- 3- Water turns into vapour.
- 4- When water collects back into lakes, rivers or seas.

| A | B | C | D |
|----------|----------|----------|----------|
| 3 | 4 | 2 | 1 |

2. Complete the following diagram with information about the water cycle:

Use the sentences in the diagram and the following linkers (First, Then, Next, Finally) to write a paragraph in your notebook:

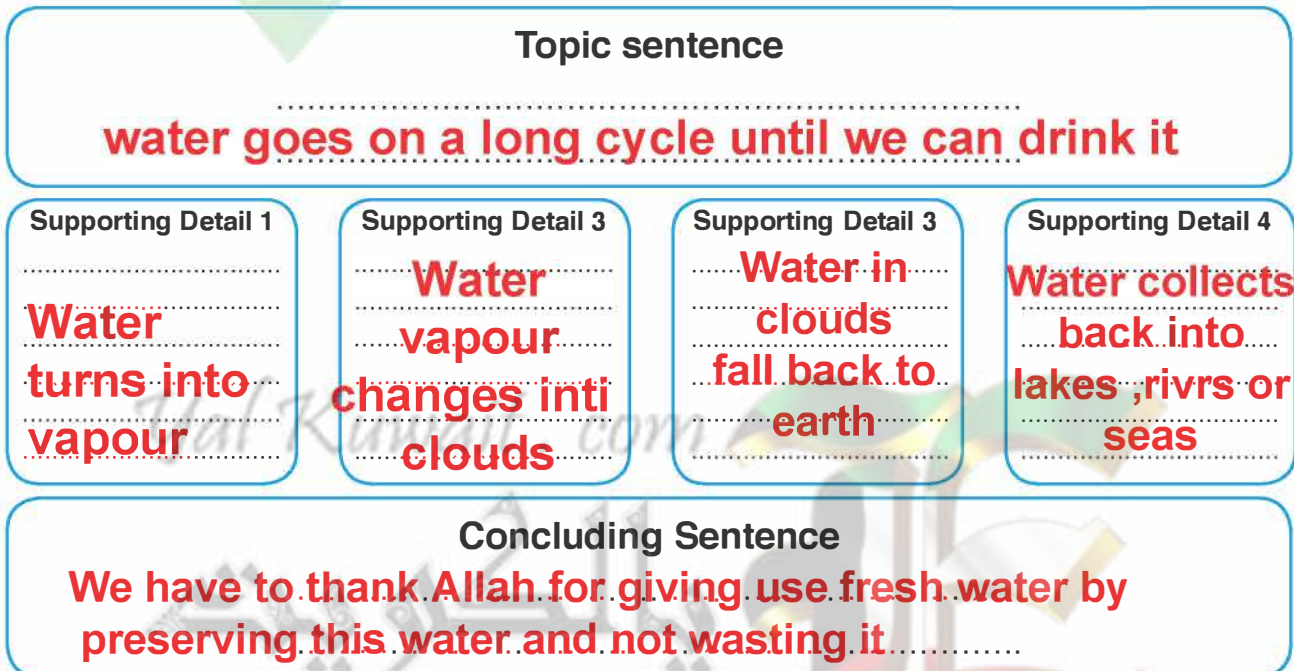

3. Use the words and pictures to write sentences in the passive following the example:

1- Goals/ score/ football
Goals are scored in football.

2- Zebras / keep/ zoo
Zebras are kept in the zoo

3- A doctor / see / hospital
A doctor is seen at the hospital

4- Books/ read/ library
Books are read in the library

5- Old coins and pots/ find/ museum
Old coins and pots are found in the museum

6- Fruits/ and vegetables/ buy/ market
Fruits and vegetables are bought at the market

7- Stars/ see/ sky
Stars are seen in the sky

4. Complete the sentences using the passive:

Money **is kept at the bank**.....

food **is kept in the fridge**.....

Books **are kept on the shelf**.....



Remember

In active sentences

(Thing doing action) + (verb) + (thing receiving action)

example: **Huda cleans the dishes.**

In passive sentences, the thing receiving the action is the subject of the sentence and the thing doing the action is optionally included near the end of the sentence.

(Thing receiving action) + (be) + (past participle of verb) + (by) + (thing doing action)

example: **The dishes are washed by Huda.**

5.  Listen and say the words.

shapes noses pictures

6.  Write each word in the correct place. Listen. Are you right?

eyes noses ducks ears lines pictures
cups exercises shapes dishes minutes

| -s sound | -iz sound | -z sound |
|---------------------------------------------------------|--------------------------------------------|--------------------------------------------------------|
| shapes ducks cups minutes | noses dishes exercises | pictures ears lines eyes |

7. Name these shapes.



t **riangle**.....



c **ircle**.....



s **quare**.....

8. Look and draw a fun picture.

Look at picture D on page (62) of your Student's Book. Use one of these shapes to make your own fun picture.

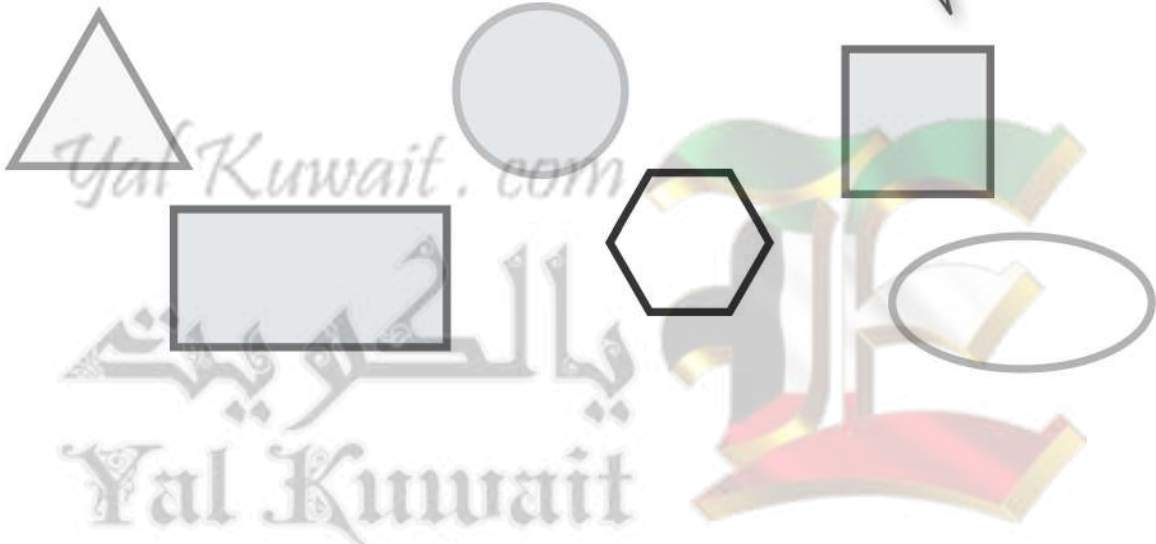

9. Read, do and make.

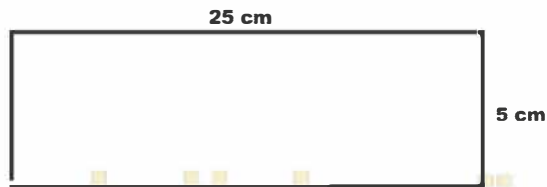
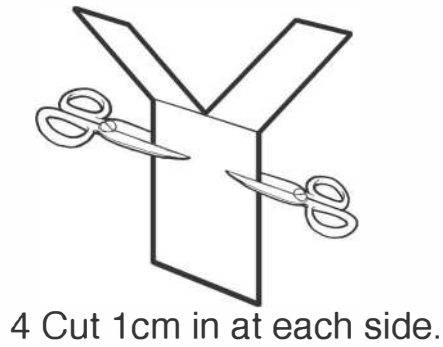
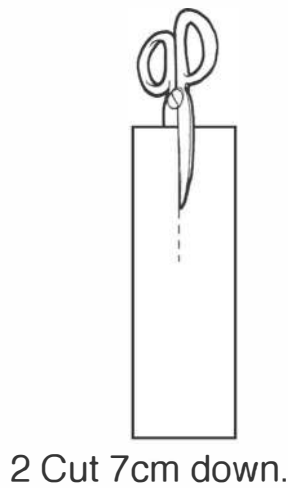

1 Get some paper 25cm x 5cm.

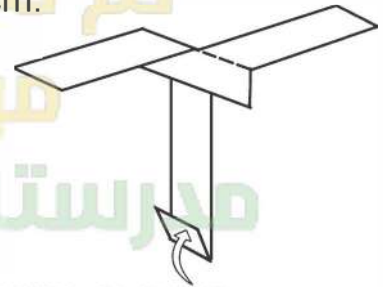

7 Hold it up. Open your hand.
What happens?

10. Complete the table:

| | |
|--------|---------------------------------|
| First | Get some paper 25cm x 5 cm..... |
| Second | Cut 7 cm down..... |
| Third | Fold the paper..... |
| Fourth | Cut 1 cm in at each side..... |

11. What did you need to do the experiment?

I needed

A piece of paper

A pen

Some colours

Scissors

A dish with some water

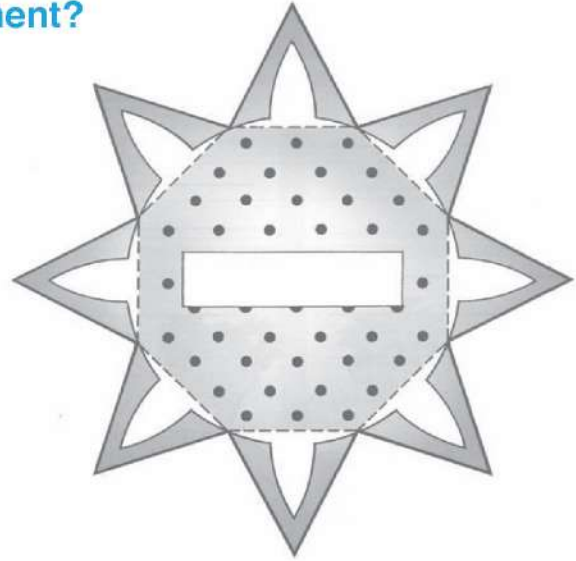

12. Write about the experiment. How is it done?

First, the picture is copied on same paper . Then ,my name is written in the middle. After that , the picture is coloured and cut out. The triangles are folded into the middle. Some water is put in a dish Finally, the picture is put on the water

13. What happened? Choose the correct word.

The shape opened/ closed.

14. Why do you think it happened?

When the picture is put on the water , it gets wet and becomes heavier so it opens like a flower

